

INSTALLATION INSTRUCTION

ITEM NO.:642 SN

1. Crossbar
2. Mounting screw
3. Wire connector
4. Canopy
5. Screws
6. Bulb
7. Glass shade
8. Glass cover
9. Metal ring
10. Tool

FEATURE:

LAMP TYPE : G9 X Max:40W 120V 60Hz
THE LAMP IS FOR INDOOR USE ONLY

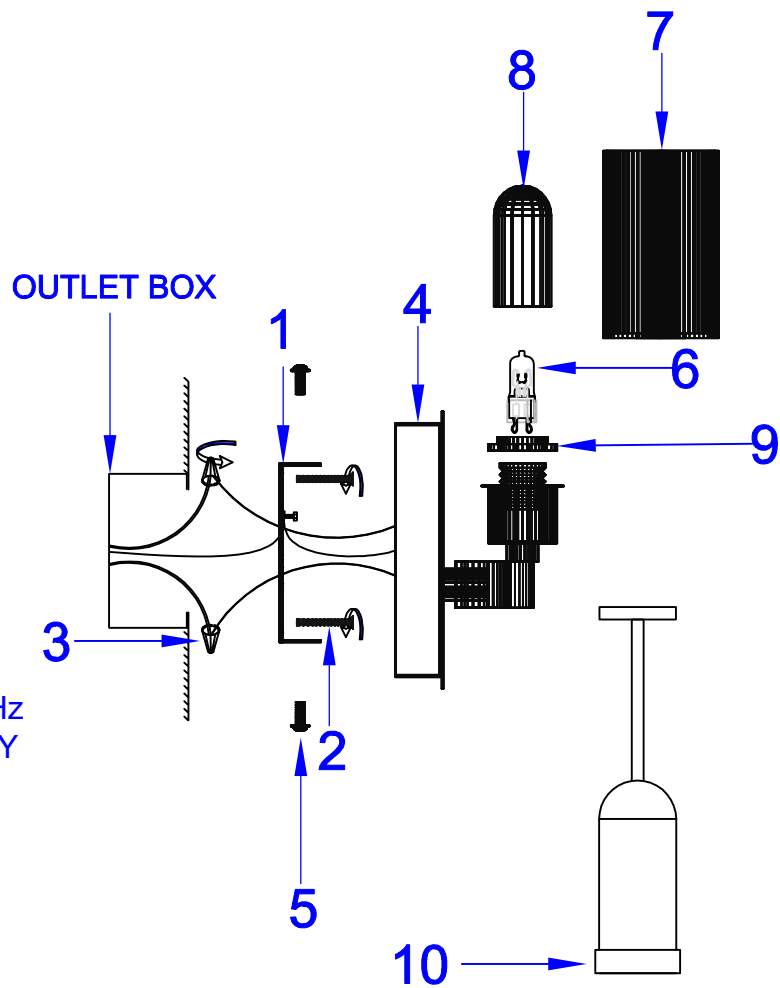

INSTALLATION INSTRUCTION

1. Shut off power at the circuit breaker and remove old fixture from wall including the crossbar.
2. Carefully remove the fixture from the carton on a clear area, and check that all parts are included as shown in the illustration.
3. Place crossbar onto outlet box, and secure Crossbar by using Mounting Screws to the Outlet Box.
4. Connect the electrical wires, making sure that all wire connectors are secured. If your outlet has a ground wire (Green or bare copper), connect the fixture Ground Wire and Bare copper together to the outlet box Ground Wire. Otherwise, connect the fixture's Ground Wire directly to the Circular Strap or Reinforcement Plate using the Green Screw provided.
5. Fix bulb to lampholder.
6. Fix glass shade to lampholder with metal ring by tool.
7. Fix glass cover to lampholder.